



FIXED FRAME SCREEN

USER MANUAL

7mm Frame		05
60mm Frame		18
90mm Frame		19

CONTENT

Guidance	02-04
Suggested Projector Placement	02
Screen Care.....	04



7mm Frame **05-17**

Parts List.....	05
Inner Frame Assembly	06
Black Backer Attachment.....	09
Fabric Attachment.....	10
Outer Frame Assembly.....	15
Wall Installation.....	15



60mm Frame **18-26**

Parts List.....	18
Frame Assembly	20



90mm Frame **19-26**

Parts List.....	19
Frame Assembly	20
Fabric Attachment.....	21
Black Backing.....	23
Support Bar Installation.....	25
Wall Installation.....	26

GUIDANCE

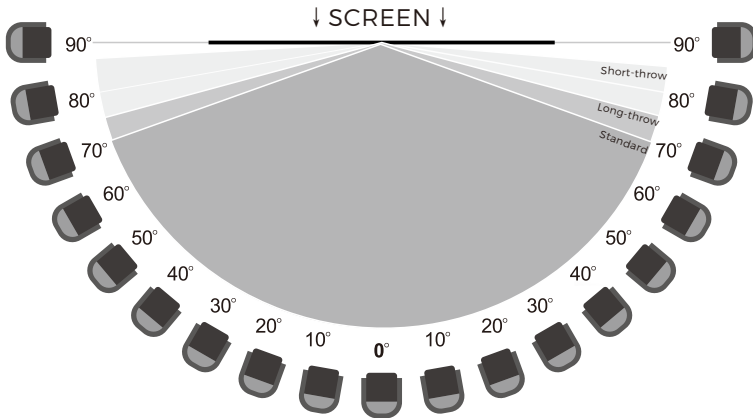

Short-throw screen user please pay attention to the direction of the screen. The screen will change according to the installation position of the projector. The recommended viewing distance is more than 2m

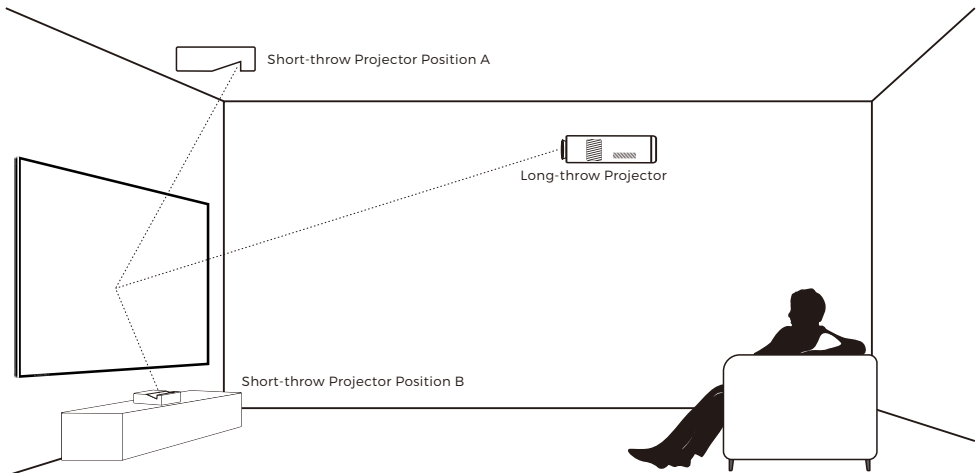

ATTENTION!! WHEN YOU SEE A " ⚠ WARNING SIGN" BE SURE TO HEED THE MESSAGE!

TO THE OWNER

Thank you for purchasing our Fixed Frame screen.

Please take a moment to read this manual carefully before assembly and installation.



DIRECTIONS

- 1) Due to the batch divergence, please refer to the actual product configuration.
- 2) The indication is for reference only, and the actual size is subject to the actual product.
- 3) Wear gloves when handling the material. Carefully unroll the screen material out onto a clean floor. Take care to not bend or crease the screen material.
- 4) It is strongly recommended that the screws be screwed into the wall studs where possible. If the wall studs cannot be used, wall anchors must be used.
- 5) Select a location that is not susceptible to moisture, dust, and is away from high traffic locations.
- 6) Please note accessories will be slightly different because of the different fabrics



Cleaning Spray



Compressed Gas Duster

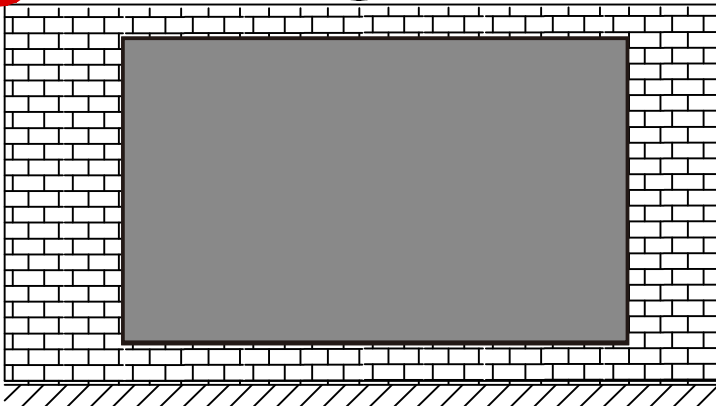

SCREEN CARE

WARNING!

Do not touch the screen directly with your hand, skin grease will cause damage to the screen coating. Avoid sharp objects from directly touching the screen surface to avoid puncturing or scratching the screen surface.- Do not use acetone, benzene, alcohol, etc. to clean the screen with organic solvents, which will cause permanent damage to the screen.

Avoid scratching the screen surface, which will cause irreparable damage

Short-throw Fabric:

For general dust, use a soft brush to clean the screen surface.

Use soft cloth to dip with mild soapy liquid or neutral detergent.

Rough object or cloth may damage the screen surface.

Screen surface has optical textures, please wipe the horizontal direction when cleaning the fabric; do not wipe it vertical direction or revolve.

Wet cleaning: with a soft towel moistened with water or diluted detergent (Do not use alcohol).Compressed gas duster is recommend.

Acoustically Transparent Fabric:

Compressed gas duster is recommend.

Dust off the screen with a dry rag. Do not use wet cloth, detergent, etc. to wipe the dust on the curtain surface.

Long-throw Fabric:

Surface can be cleaned as follows:

1.Using a white clean cloth(100% cotton preferred) that is dampened with clear water, gently wipe the area in one direction. Do not use a circulate motion. Using a fry 100% cotton cloth ,wipe dry after each cleaning and before folding and storing.

2.To clean a stubborn stain or sticky surface, use denatured alcohol(methanol or methyl alcohol) following he same procedure as for water.

OR.

1. Lint-Free white cloths, Mild Soap (hand soap is suitable) and Water.

2. Take the Lint-Free cloth and submerge it in warm water for cleaning light dust and dirt. For stubborn stains or a sticky surface, a solution of mild dishwashing liquid diluted with warm water should be used.

3. Completely ring out the cloth so it is lightly dampened, not drenched.

4. Using the damp cloth, lightly wipe in an up and down motion starting at the left of the screen moving to the right of the

screen. DO NOT WIPE IN CIRCULAR MOTION.

5. Once you have completed wiping the entire screen with a dampened Lint-Free cloth, use the dry Lint-Free cloth to wipe off any excess water from the screen.

Standard Fabric:

Using a white clean cloth (100% cotton preferred) that is dampened with clear water, gently wipe the area in one direction. Do not use a circular motion. Using a dry 100% cotton cloth, wipe dry after each cleaning session. To clean a stubborn stain or a sticky surface, use denatured alcohol (methanol or methyl alcohol) following the same procedure as for water.



7mm Frame

PARTS

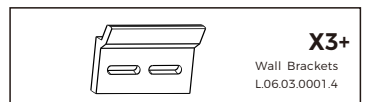
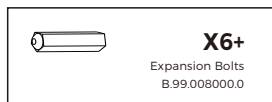
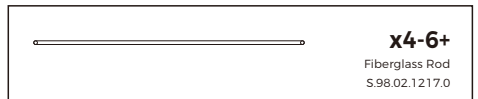
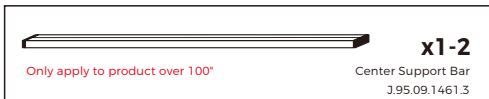
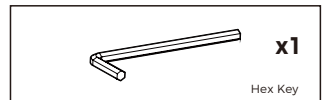
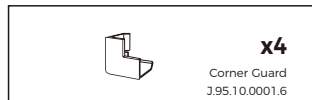
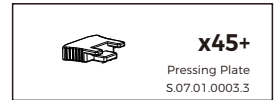
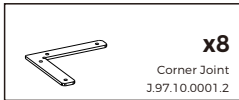
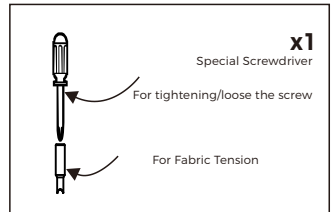
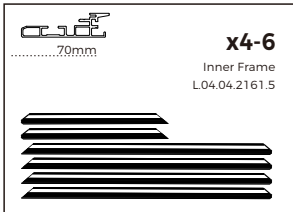
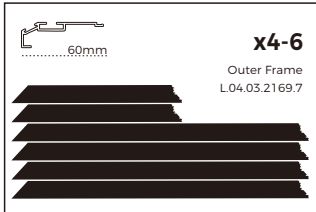
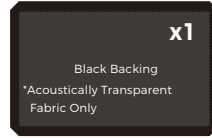

Additional Tools



ATTENTION

Please make sure all parts are included in your package before assembling your screen.



7mm Frame

PARTS

x1
Non-Woven Floor Mat

x1
Screen

x1
Black Backing
*Acoustically Transparent
Fabric Only

x1
MANUAL



x4-6
Outer Frame
L.04.03.2169.7

x4-6
Inner Frame
L.04.04.2161.5

x1
Special Screwdriver

For tightening/loose the screw

For Fabric Tension

x12
Corner Joint
J.97.10.0001.2

x6
Splice Bar
J.97.09.0002.2

Split Frame Only

x45+
Pressing Plate
S.07.01.0003.3

x72+
Splice Bar Screws
(Hex socket)

x4
Corner Guard
J.95.10.0001.6

x1
Hex Key

x1-2
Center Support Bar
J.95.09.1461.3

Only apply to product over 100"

x4-6+
Fiberglass Rod
S.98.02.1217.0

X6+
Mounting Screws(4x38mm)
B.13.04.0120.6

X6+
Expansion Bolts
B.99.008000.0

X3+
Wall Brackets
L.06.03.0001.4

Additional Tools



ATTENTION

Please make sure all parts are included in your package before assembling your screen.

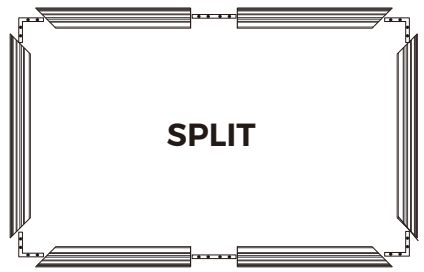

1-A

Please check the frame type(A type[70mm width]/B type[80mm width]) first, then install the Splice Bar/Corner Joint.

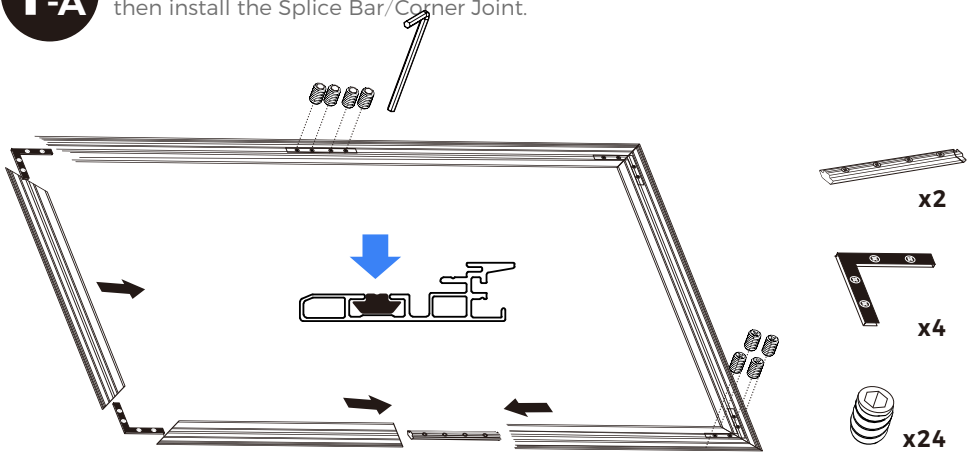

1-B

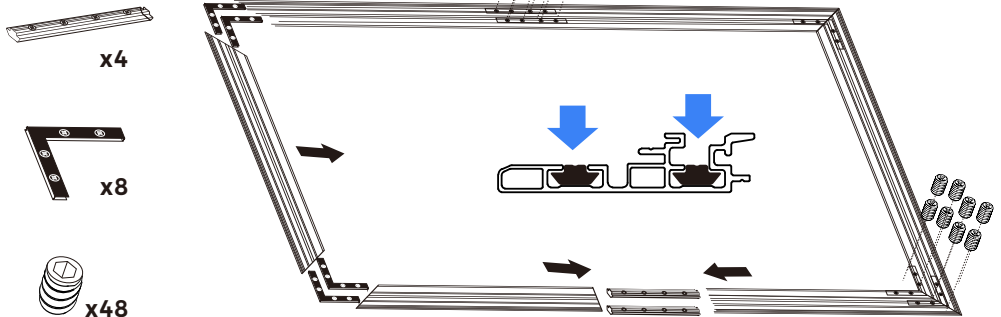
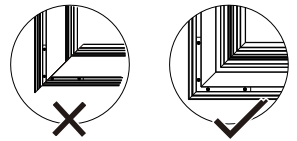

2

Attach Center Support Bar into the frame and slide it into the groove

1



Only apply to product over 100"

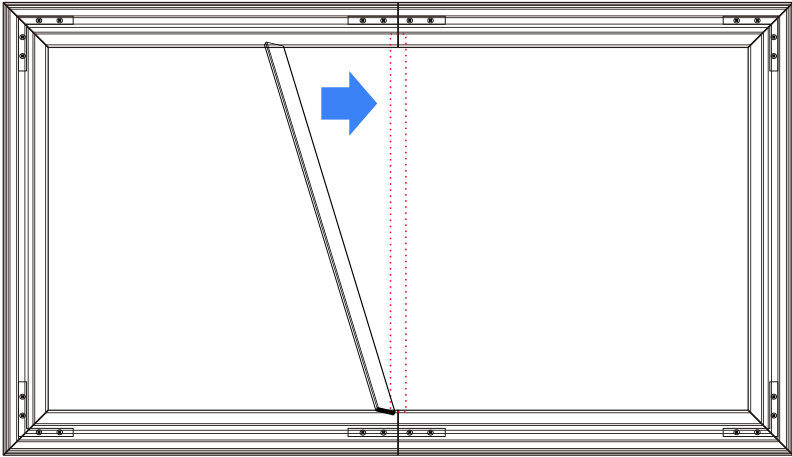

2

3

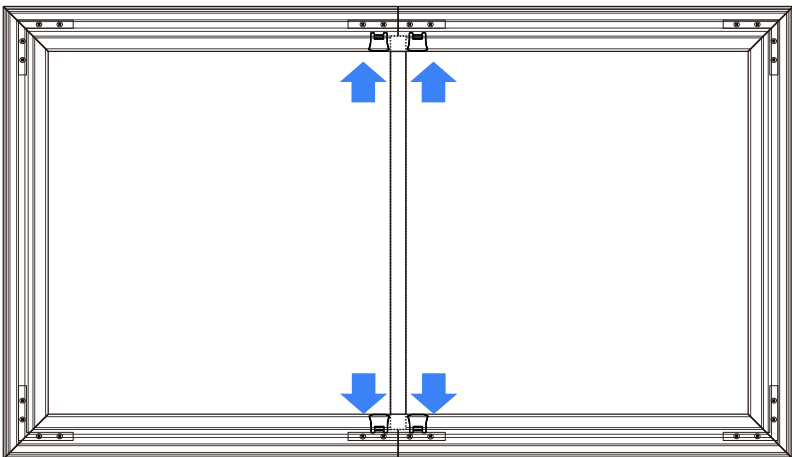

BLACK BACKER ATTACHMENT



Acoustically Transparent materials come with a black backer that must be installed to eliminate shine through. Attach the light-absorbing black velvet fabric onto the Hook(frame)

x1
Black Backing

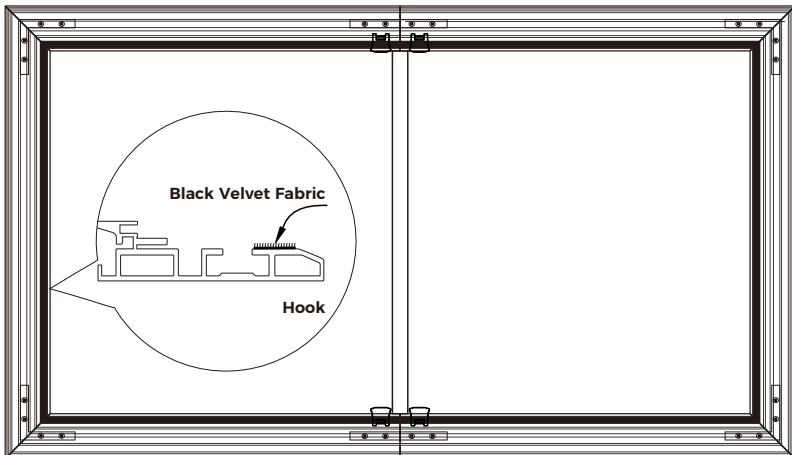
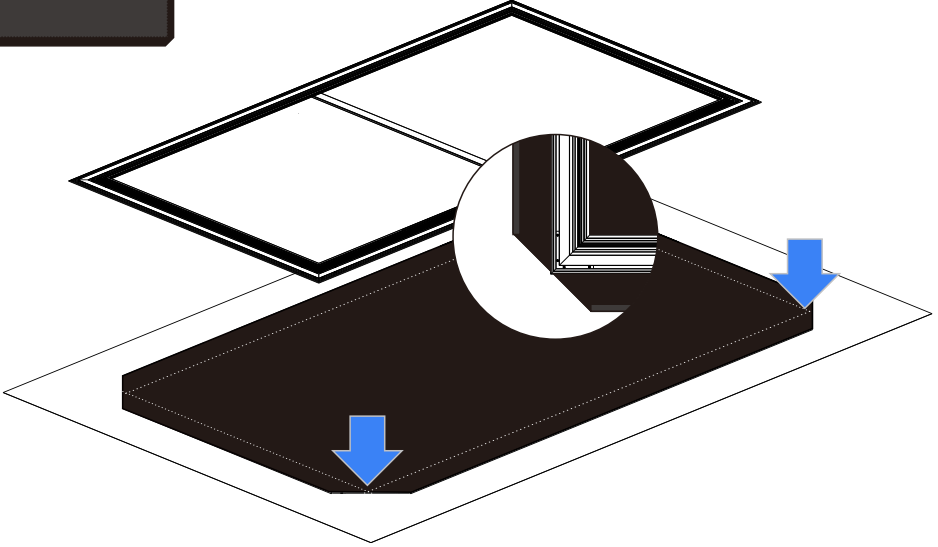

FABRIC ATTACHMENT

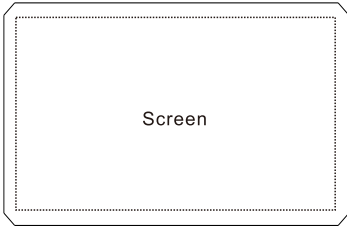

x1



Wear gloves when handling material.



Carefully unroll the screen material out onto a clean floor. Take care to not bend or crease the screen material.

x4-6



Please make sure keep the front(projection side) of the material face down when unrolling the screen material out onto the Non-woven floor mat.

ATTENTION: There are also has labels on the screen material to help distinguish the correct direction.

4

Insert the Fiberglass Rod separately into the edges of all four corners of the material.

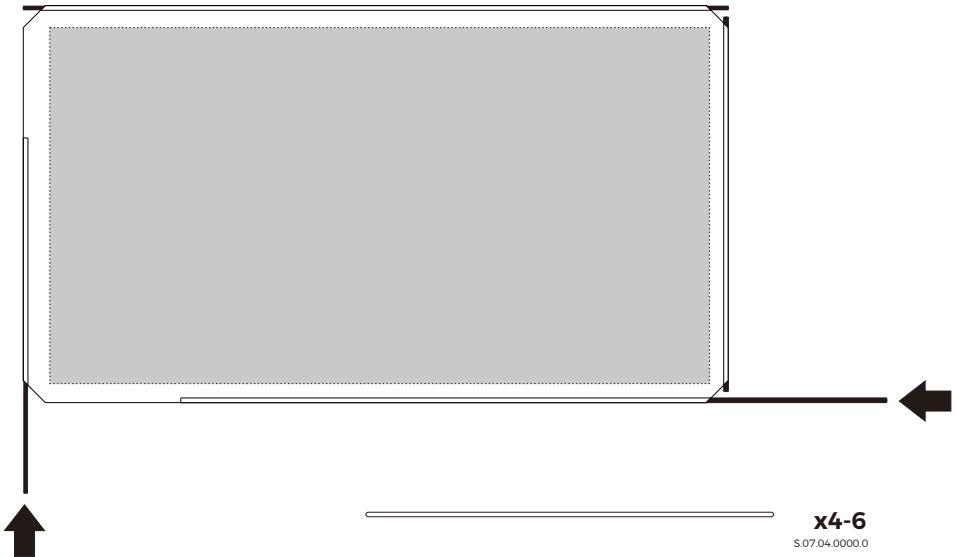

5

Lay the screen material (screen projection side facing down) under the frame. Place the assembled inner frame into the material as below.

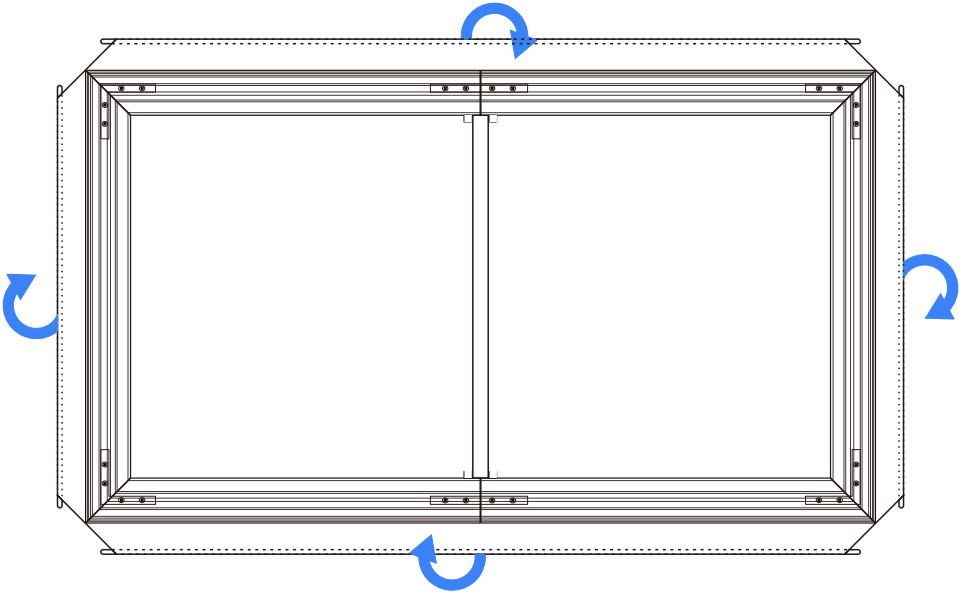
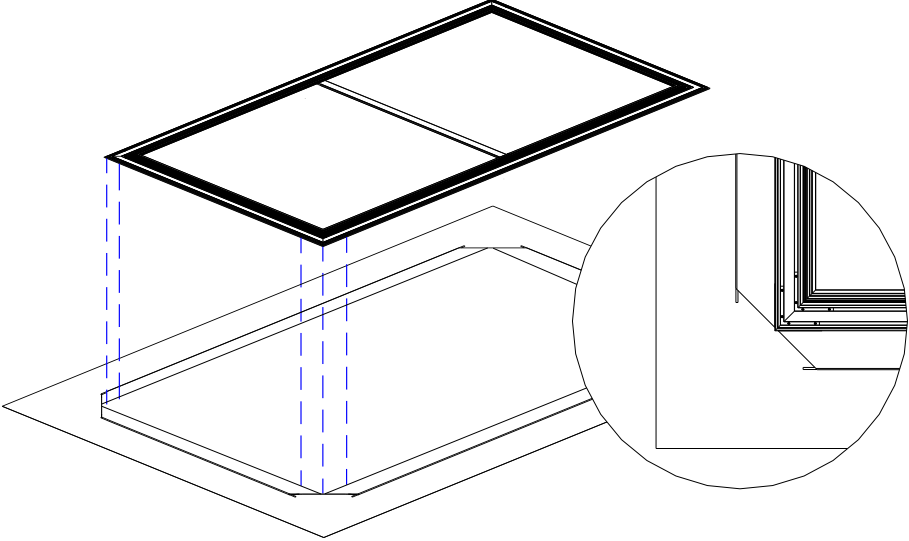

6

Stretch the Fiberglass Rod in the direction of the arrowhead, then use the Pressing Plate fix screen material in each frame corner (1 → 2 → 3 → 4).

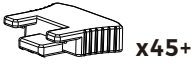

After all four corners have been attached; please check whether the screen surface is flat. If not, please loosen the pressing plate and pull the fabric tighter.

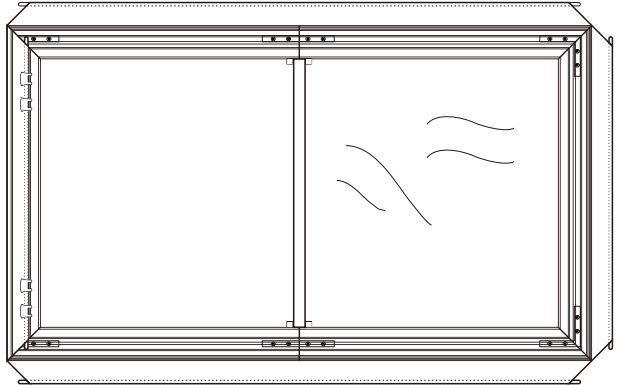
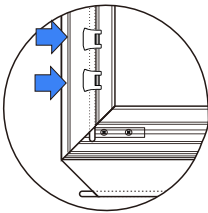
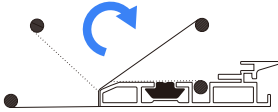

1

4

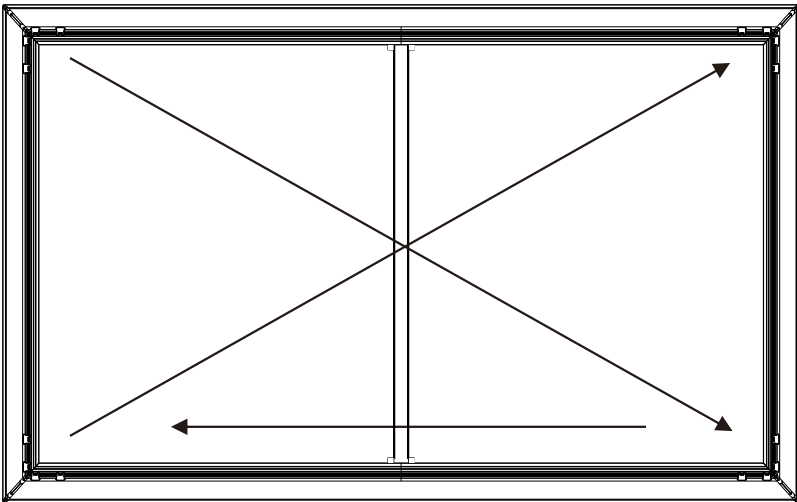

3

2

7

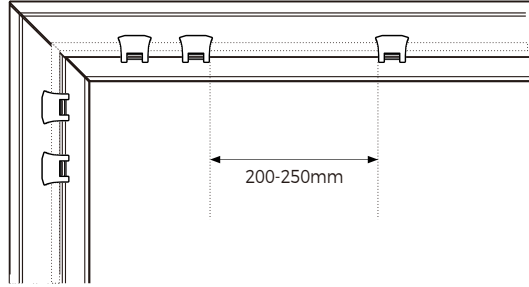
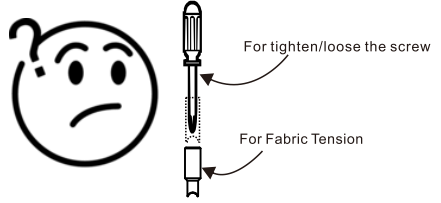
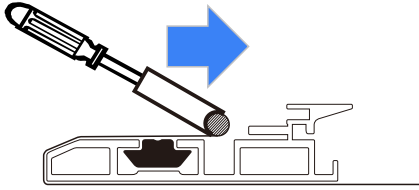

Spacing 200-250/mm apart to prevent crowding. If short on usage, please measuring the fabric and rearrange the layout.

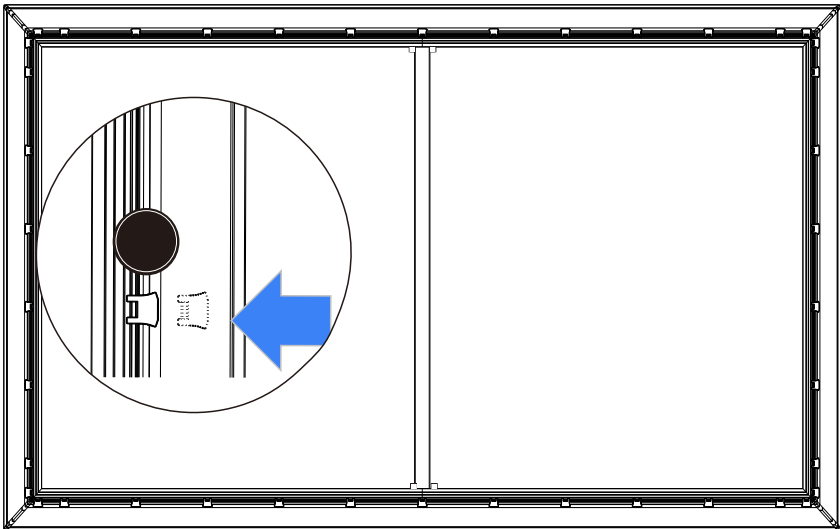
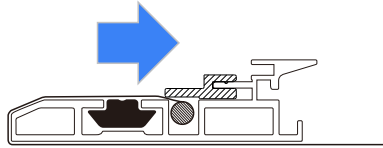
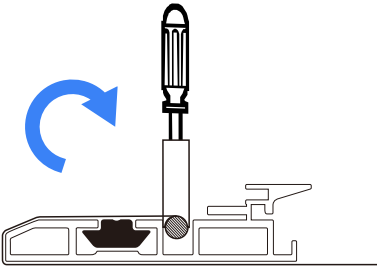

8

Flip the screen to the front, make sure the screen material is flat. If not, takedown the Pressing Plate and stretch the screen material corner, and reattach.

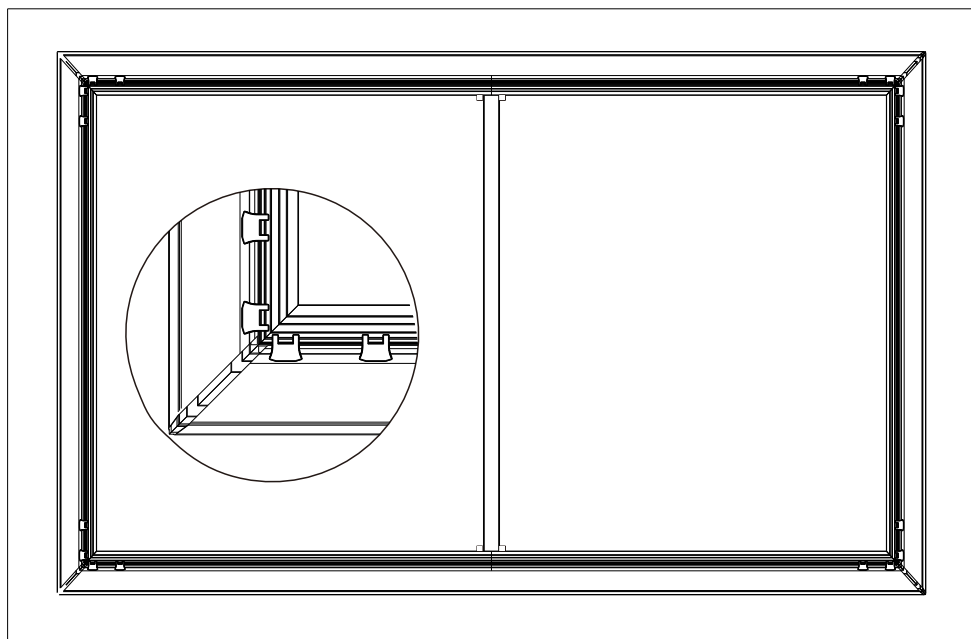
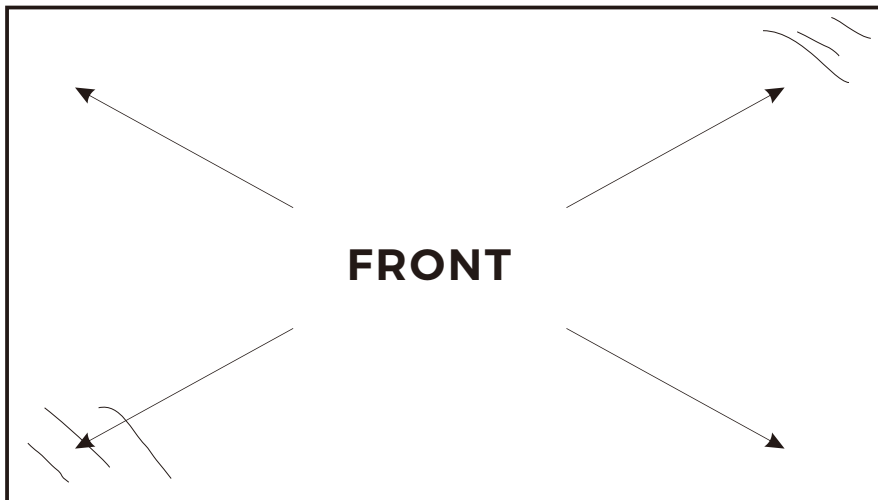



x4-6



x2



x8



9

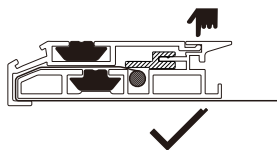
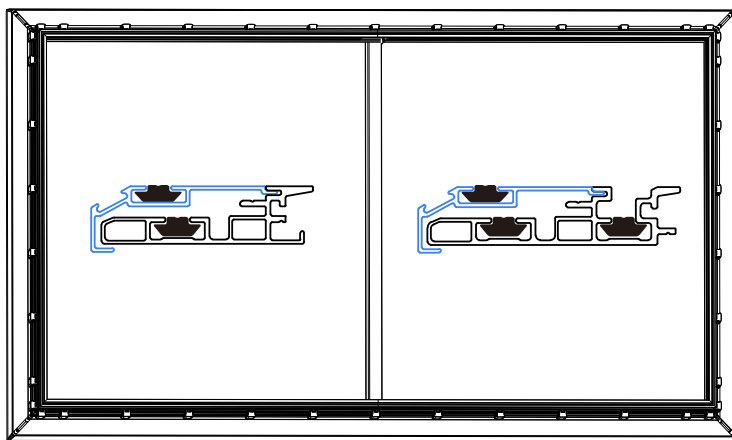
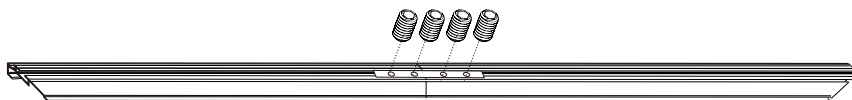
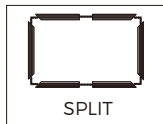

10



x1



x16



x4

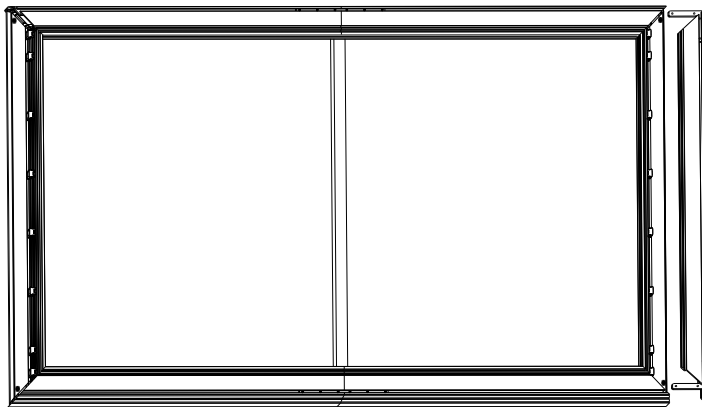
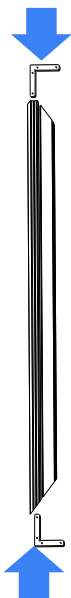

11



x4

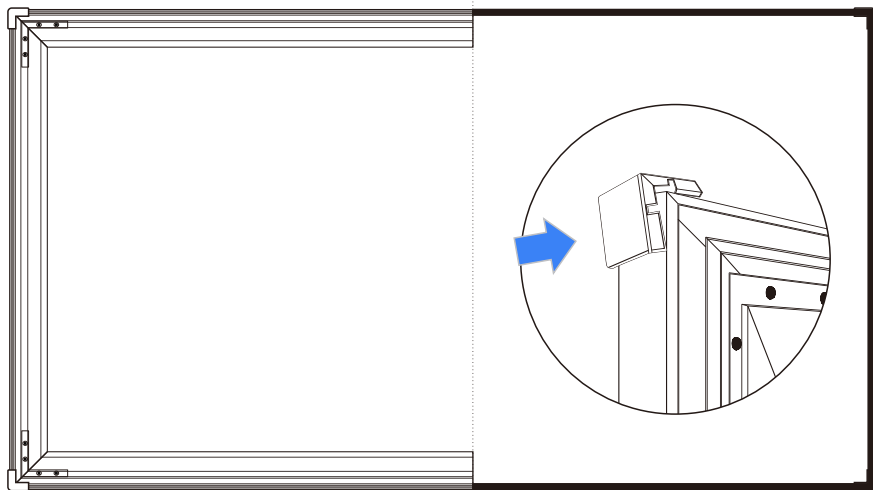

WALL INSTALLATION

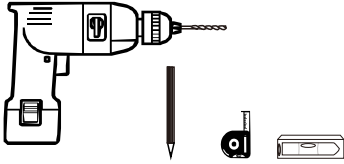

Please distinguish the correct direction before attaching the Short-throw fabric screen to the wall.



x6+

Mounting Screws(4x38mm)
B.13.04.0120.6



x6+

Expansion Bolts
B.99.008000.0

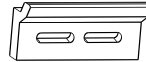

x3+

Wall Brackets
L.06.03.0001.4

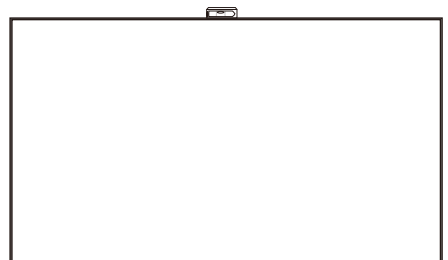
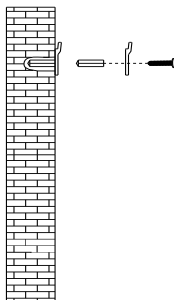
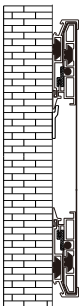
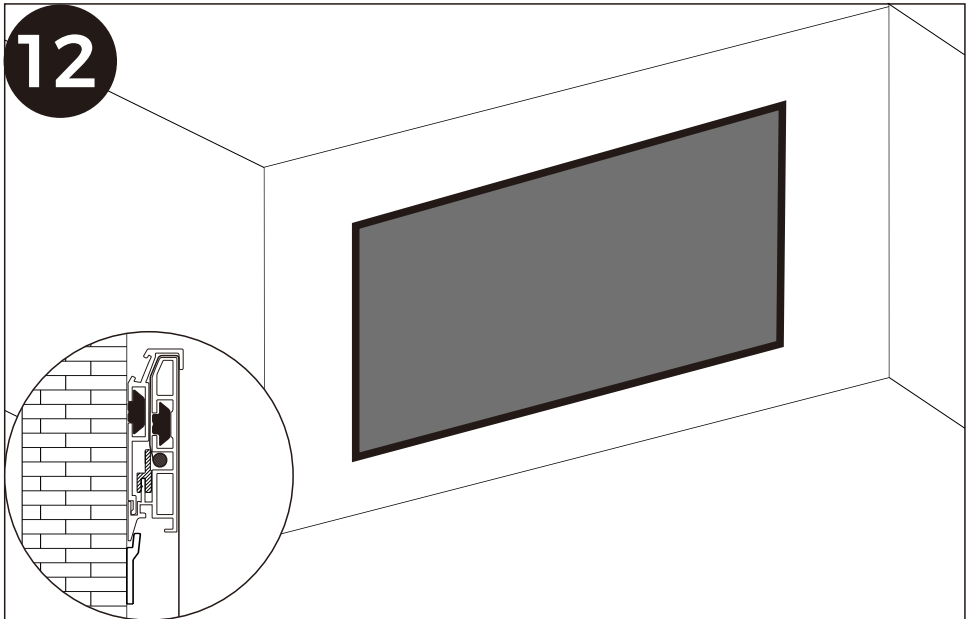

PARTS

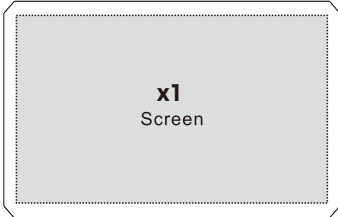

x1

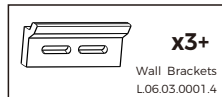
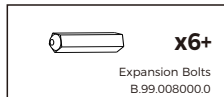
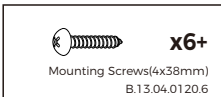
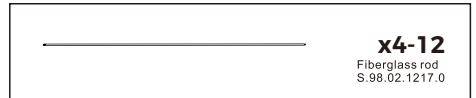
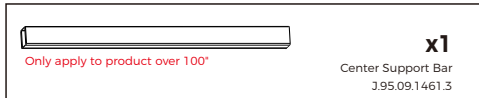
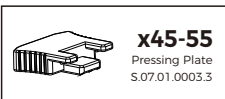
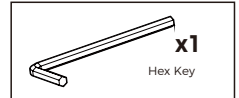
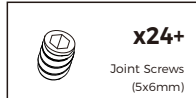
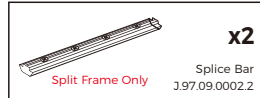
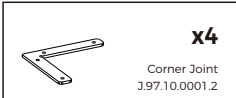
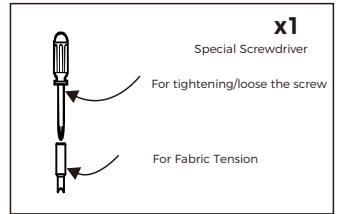
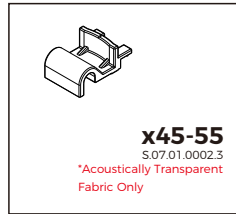
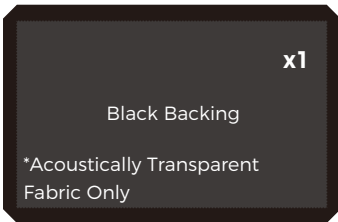

Additional Tools



ATTENTION

Please make sure all parts are included in your package before assembling your screen.

PARTS

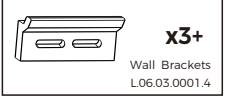
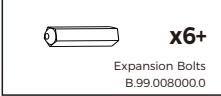
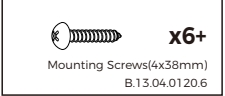
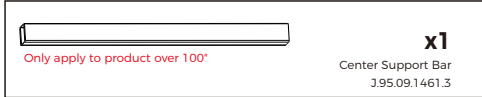
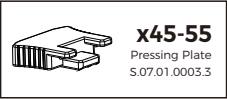
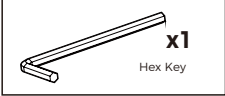
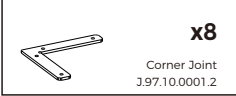
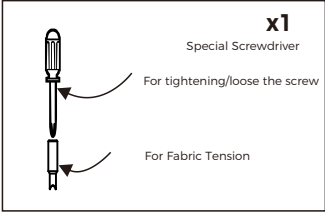
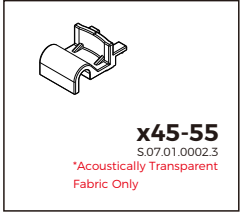
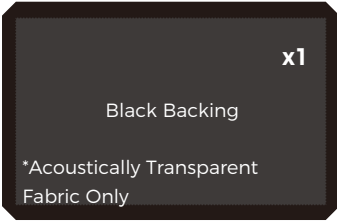
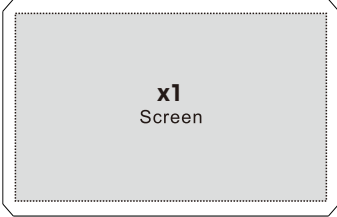

Additional Tools



ATTENTION
Please make sure all parts are included in your package before assembling your screen.

FRAME ASSEMBLY

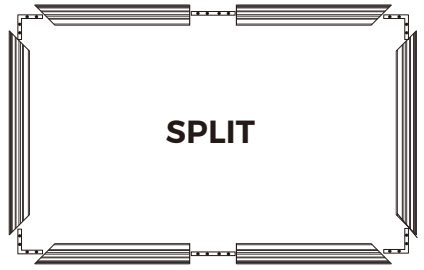

60mm Frame



90mm Frame

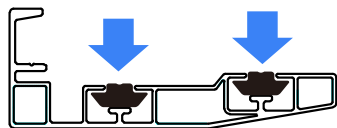
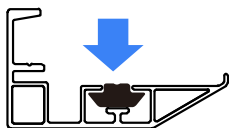
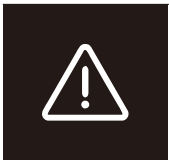
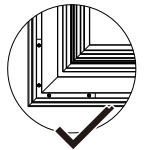
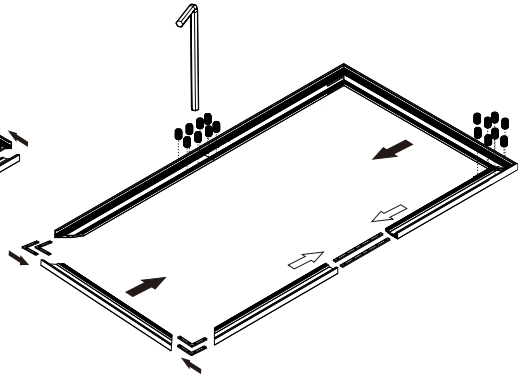
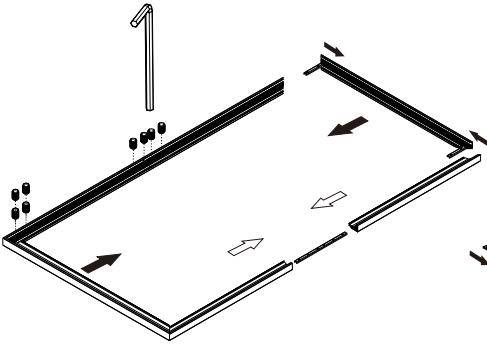

FABRIC ATTACHMENT

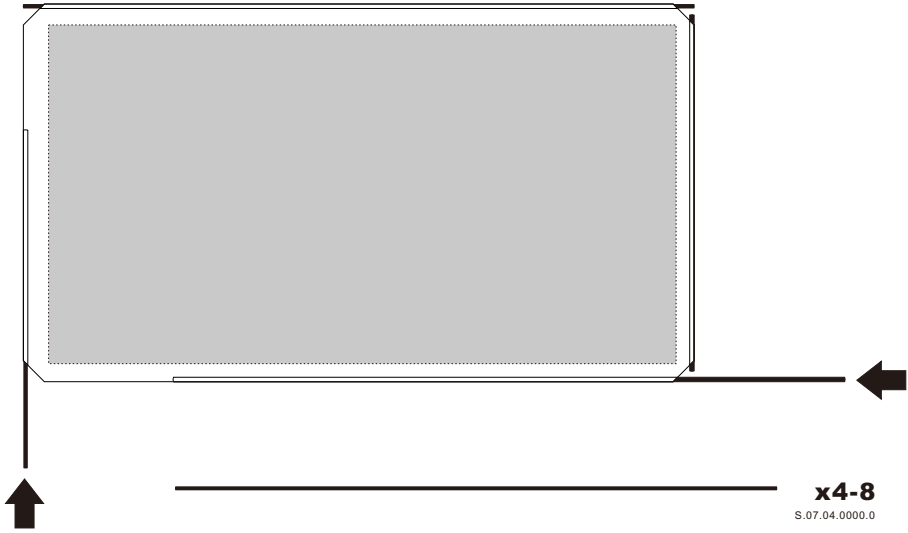

X45-55

Pressing Plate
S.07.01.0003.3

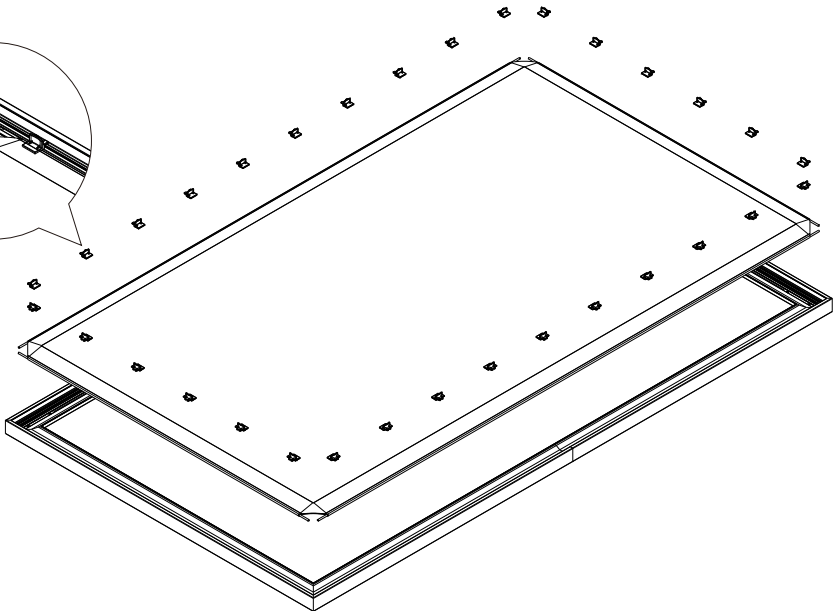
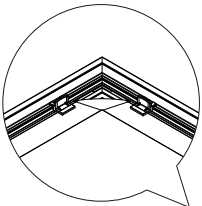

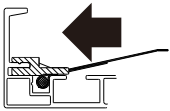
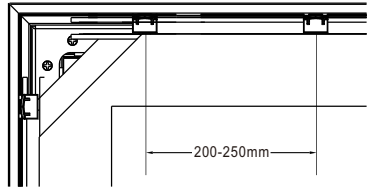
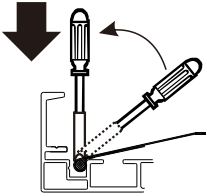
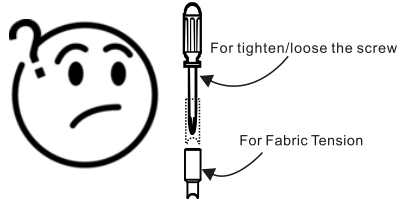
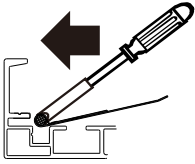

Spacing 200-250/mm apart to prevent crowding. If short on usage, please measuring the fabric and rearrange the layout.

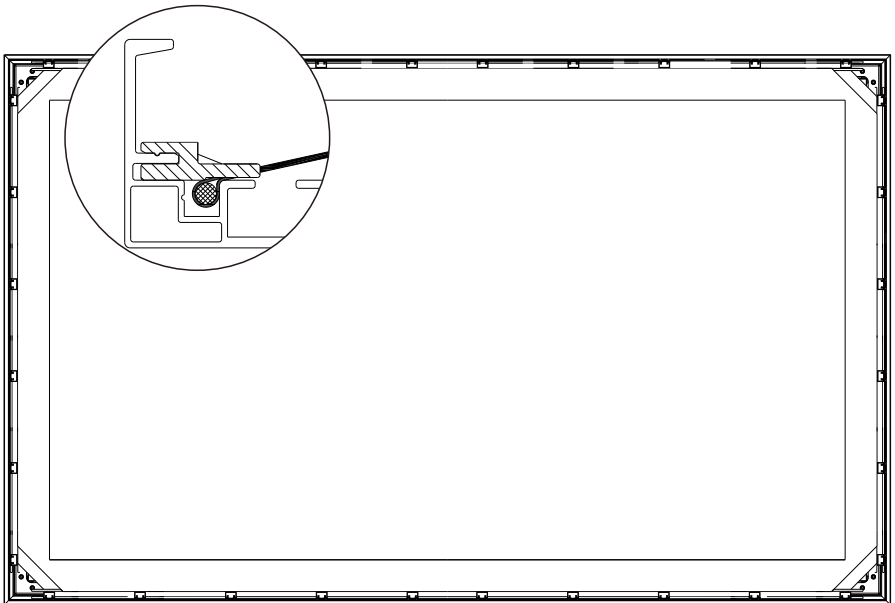

BLACK BACKER ATTACHMENT

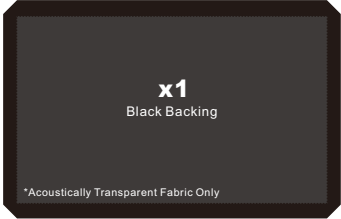

x30+
S.07.01.0002.3

_____ **x4-8**
S.07.04.0000.0

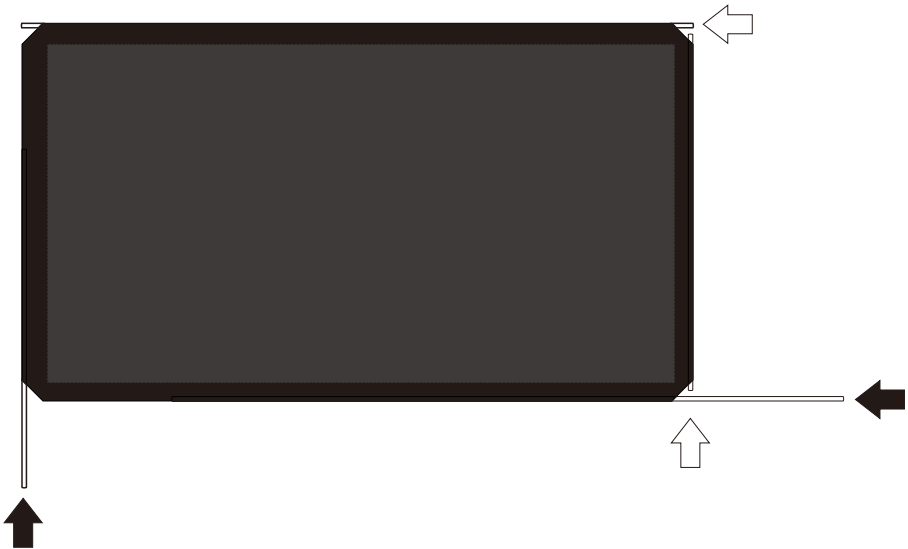

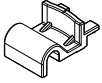

x30+
S.07.01.0002.3

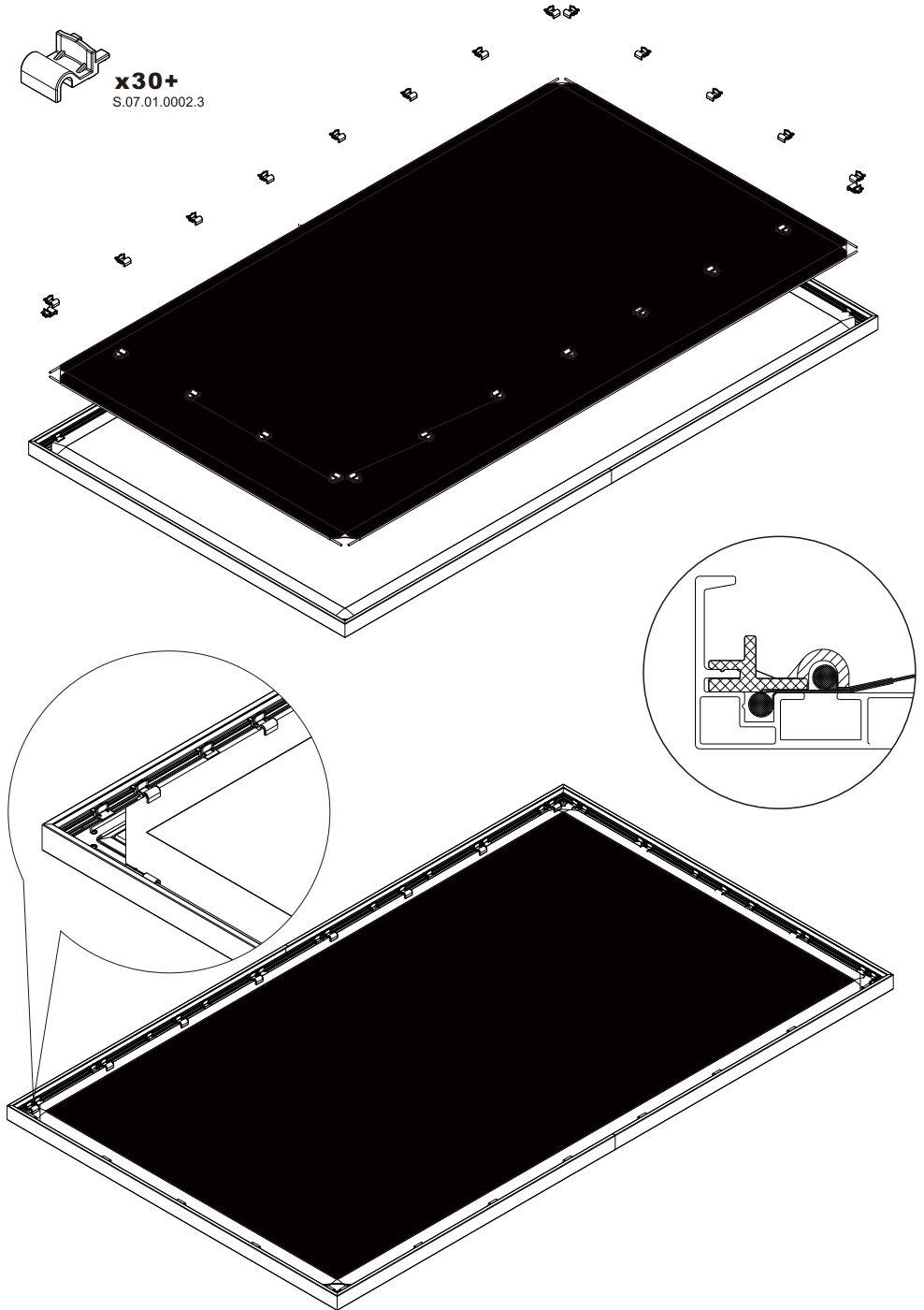

SUPPORT BAR INSTALLATION



x1

S.07.04.0000.0

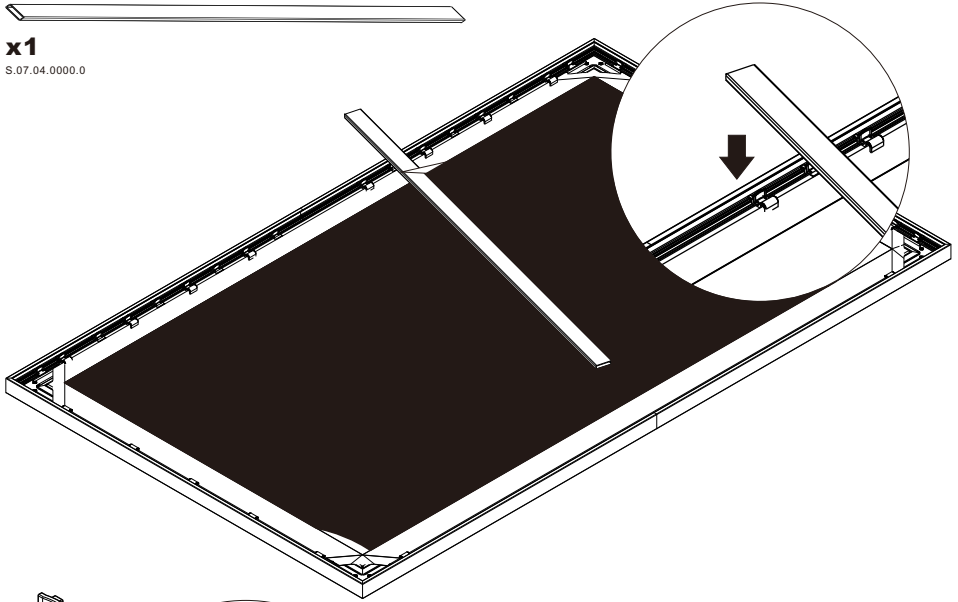

x4

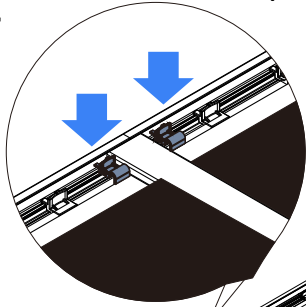

In order to fix the Center Support Bar onto the frame, please squeeze 2 Pressing Plates on each end

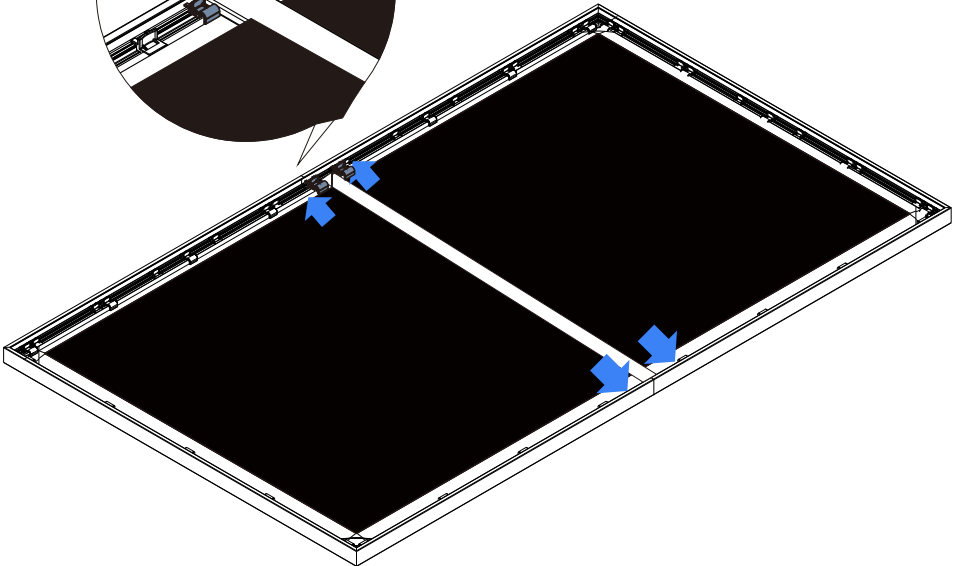

WALL INSTALLATION



x6+

Mounting Screws(4x38mm)
B.13.04.0120.6



x6+

Expansion Bolts
B.99.008000.0

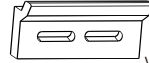

x3+

Wall Brackets
L.06.03.0001.4

