

SCREEN PRO 

MOTORIZED SCREEN SERIES

USER MANUAL

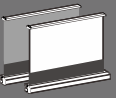

06

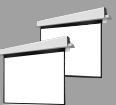

10



18

EN.

Please read this instruction manual carefully before connecting, operating or adjusting this machine.
Please keep this manual in a safe place for future reference.
Actual product may vary from image shown. Product specifications subject to change without notice.

Language Version

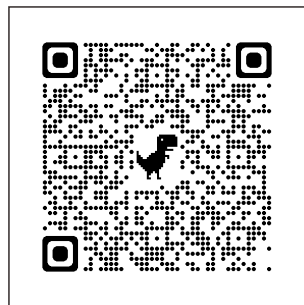

DE [Deutsch]

EN [English]

ES [Spanyol]

FR [Français]

IT [Italiano]

ZH [中文]

TABLE OF CONTENTS

Guidance.....2-5

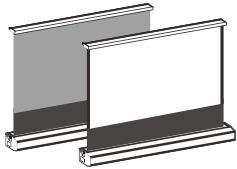

Self-Rising Screen

Parts.....6
Adjustment And Usage.....7

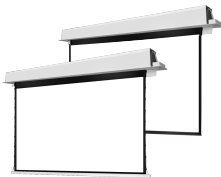

Ceiling-Recessed Screen

Parts.....10
Installation.....11
Adjustment And Usage.....16



Motorized Screens

Parts.....18
Installation.....19
Adjustment And Usage.....22



Parts.....20
Installation.....21
Adjustment And Usage.....22

Controls Using 3rd Party23
Troubleshooting.....24
Sync-Trigger Instruction.....25

*T-Type: standard tubular motor limit setting(tool required)
*E-Type: electronic tubular motor limit setting

SAFETY PRECAUTIONS [PLEASE OBEY]

To avoid personal injury or property damage, please observe the following. Failure to comply with the following steps will result in a void of the manufacturer's warranty. The dealer/installer will be responsible for all costs associated with failure to comply, including replacement parts, and/or additional on-site visits needed for repair work.

| WARNING | |
|---|--|
|  | <ul style="list-style-type: none">• Be careful not to approach toddlers, and place the remote control away from children. (So as not to cause injury due to mishandling.)• Do not put fingers or other objects into the support arm during lifting. (So as not to cause injury)• Be careful of the electric screen in motion. When the electric screen is running, no one is allowed to stand under it. (So as not to cause injury.) |
|  | <ul style="list-style-type: none">• This product must be installed on a solid ceiling, and make sure that the metal parts and installation screws do not touch any metal products in the ceiling, such as metal slats, cable slats, and metal plates. (so as not to cause electric shock)• If the power supply cord is damaged, it must be replaced by the manufacturer's maintenance department or a professional. (Do not use ordinary cables instead, so as not to cause malfunction, fire, or electric shock)• If any abnormal phenomenon occurs, please stop using this product and disconnect the power supply.• Please ensure the screen is connected to a grounded socket to avoid the possibility of electric shock.• Pay attention during installation to prevent the installer from falling and the product from dropping. (so as not to cause personal injury or machine damage) |

| ATTENTION | |
|---|--|
|  | <ul style="list-style-type: none">• Do not run the screen continuously for more than 4 minutes (the overheating protection function will stop the motor in case of overheating. After the motor cools down in about 20 minutes, you can re-operate the screen)• The matte white surface can be washed with a soft towel dampened with water or weak alkaline detergent. (Do not wash with alcohol or ether liquid)• Do not scratch or fold the screen.• Do not lift the bottom bar with your hands or press down on the hatch during the process (to avoid causing the surface to be damaged)• Keep away from high temperature/ignition/steam.• Do not put sundries into the machine. After use, please check and confirm the cleanliness of the screen/surface before retracting the fabric. (so as not to cause damage to the screen) |

GUIDANCE

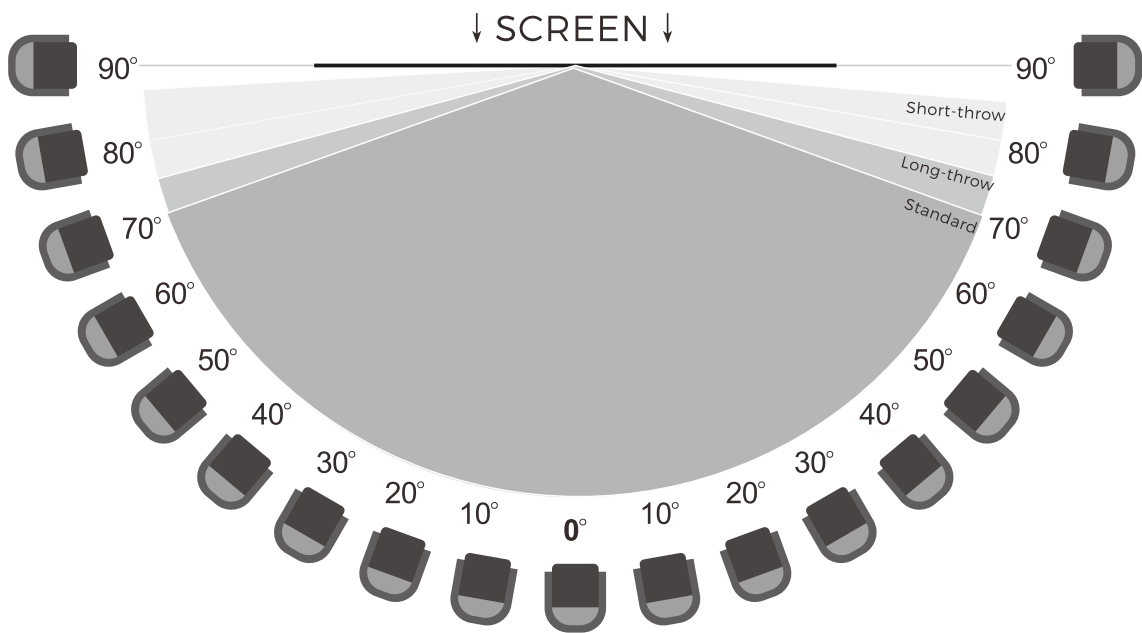

Short-throw screen user, please pay attention to the direction of the screen.
The screen will change according to the installation position of the projector.
The recommended viewing distance is more than 2m

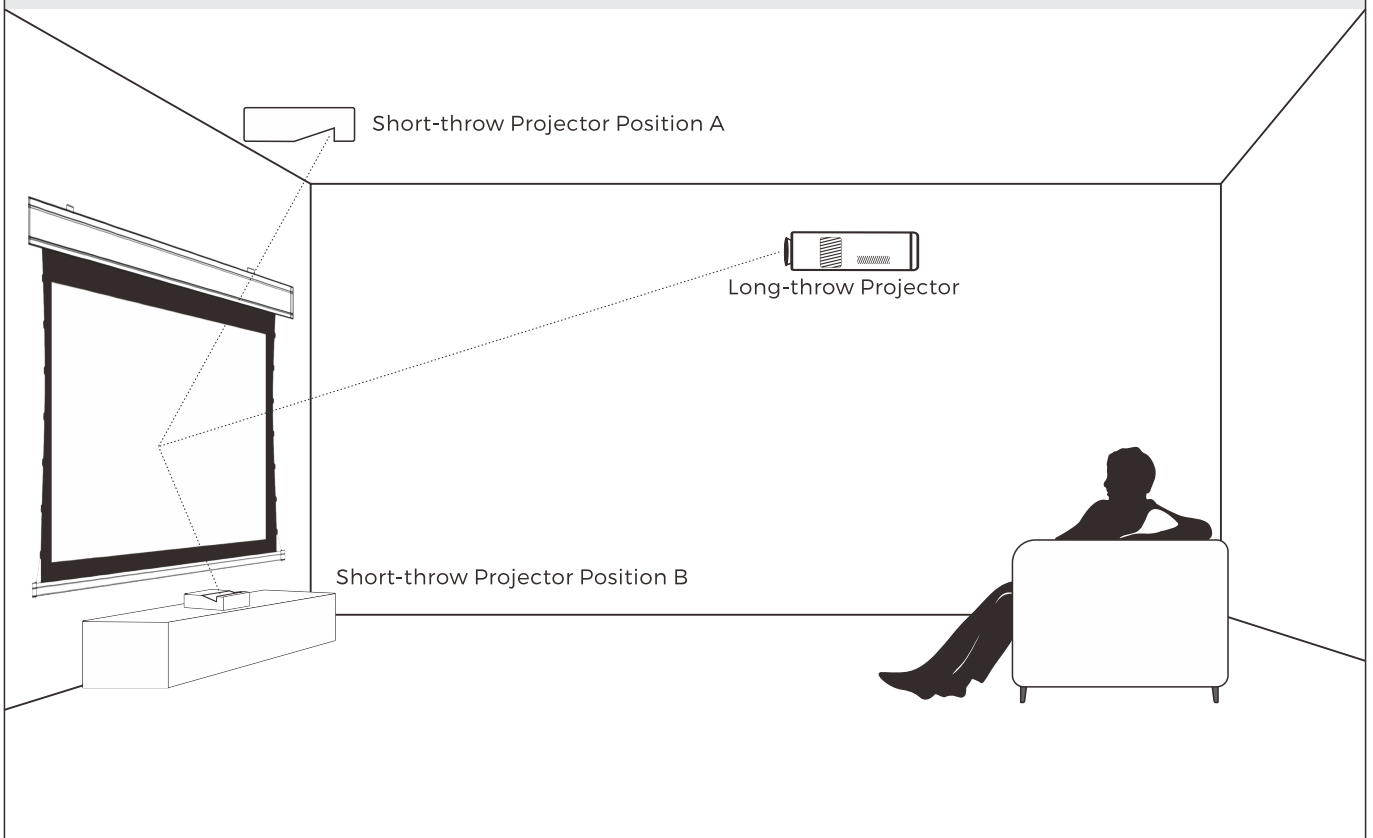

SCREEN CARE



- Avoid sharp objects from directly touching the screen surface.
- Avoid scratching the screen surface, which will cause irreparable damage.
- Do not touch the screen surface directly with your hand, skin grease will cause damage to the screen coating.
- If involved with acetone, benzene, alcohol, etc., please consult your dealer first

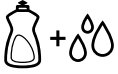

Short-throw Fabric:

For general dust, use a soft brush to clean the screen surface.

Use a soft cloth to dip with mild soapy liquid or neutral detergent.

Rough objects or clothes may damage the screen surface.

The screen surface has optical textures, please wipe the horizontal direction when cleaning the fabric; do not wipe it vertical direction or revolve.

Wet cleaning: with a soft towel moistened with water or diluted detergent (Do not use alcohol). Compressed gas duster is recommended.



Acoustically Transparent Fabric:

Compressed gas duster is recommended.

Dust off the screen with a dry rag. Do not use wet cloth, detergent, etc. to wipe the dust on the curtain surface.



Long-throw Fabric:

The surface can be cleaned as follows:

1. Using a white clean cloth(100% cotton preferred) and dampened with clear water, gently wipe the area in one direction. Do not use a circulate motion. Using a fry 100% cotton cloth, wipe dry after each cleaning and before folding and storing.
2. To clean a stubborn stain or sticky surface, use denatured alcohol(methanol or methyl alcohol) following the same procedure as for water.

OR.

1. Lint-free white cloths, Mild Soap (hand soap is suitable), and water.
2. Take the Lint-Free cloth and submerge it in warm water for cleaning light dust and dirt. For stubborn stains or a sticky surface, a solution of mild dishwashing liquid diluted with warm water should be used.
3. Completely ring out the cloth so it is lightly dampened, and not drenched.
4. Using the damp cloth, lightly wipe in an up-and-down motion starting at the left of the screen and moving to the right of the screen. DO NOT WIPE IN CIRCULAR MOTION.
5. Once you have completed wiping the entire screen with a dampened Lint-Free cloth, use the dry Lint-Free cloth to wipe off any excess water from the screen.



Standard Fabric:

Using a white clean cloth (100% cotton preferred) that is dampened with clear water, gently wipe the area in one direction. Do not use a circular motion. Using a dry 100% cotton cloth, wipe dry after each cleaning session. To clean a stubborn stain or a sticky surface, use denatured alcohol (methanol or methyl alcohol) following the same procedure as for water.

Self-Rising Screen

PARTS

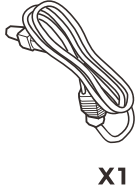
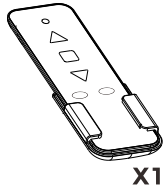

ADJUSTMENT AND USAGE

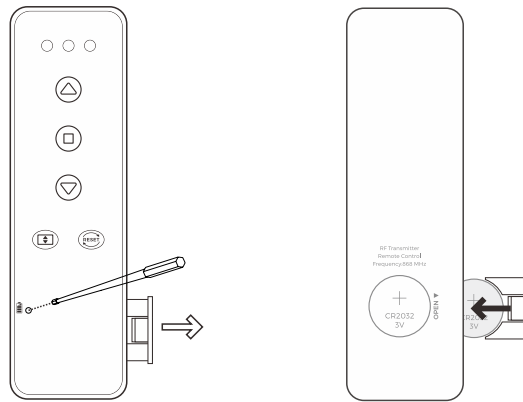
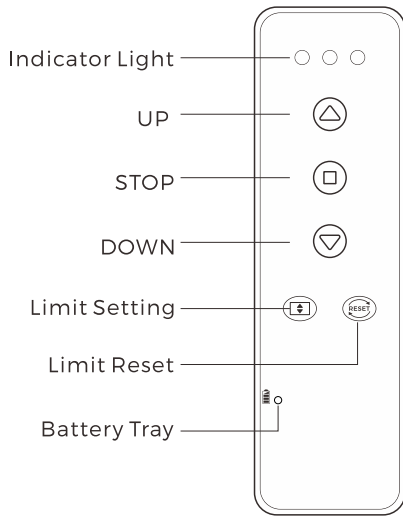

! **Low battery notification: A red indicator light shows that the battery (CR2032) needs to be replaced.**

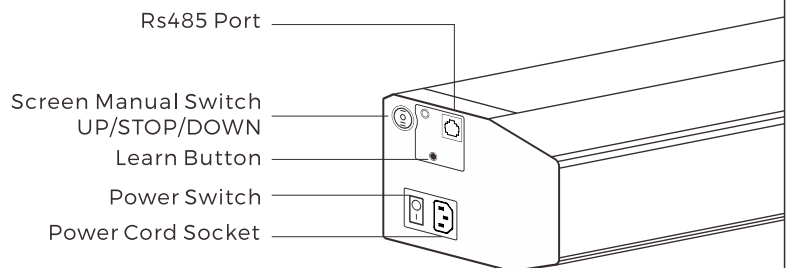
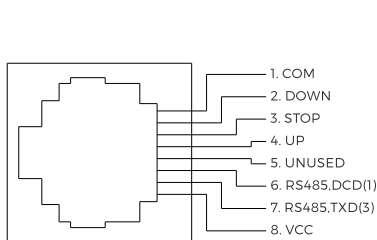

SCREEN HEIGHT ADJUSTMENT

(E-Type Motor Limit Setting)



NOTE: When you operate the projection screen runs down/up 4 times(uninterrupted), the CHILD LOCK function is activated. the screen cannot be operated temporarily for about 30mins. This function is set to prevent accidents caused by humans or children playing, and cannot turn off.

- ATTENTION: The screen height has been pre-set from the factory (has reached the limit), the user can only lower the screen height!



- **Do Not Set the Limit Over Than Default!**

WARNING!



Default Limit switches are located inside the housing and should only be adjusted by Authorized Personnel Only! We only recommend that professionals undertake the default limit adjustment (has been pre-set before leaving the factory). The warranty does not cover the after-sales problems caused by this. If adjustment is necessary, please contact the dealer!

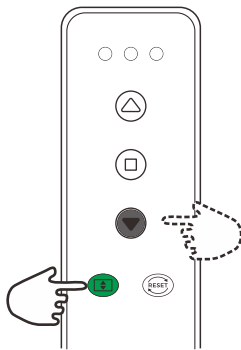

Beep.....3-beeps

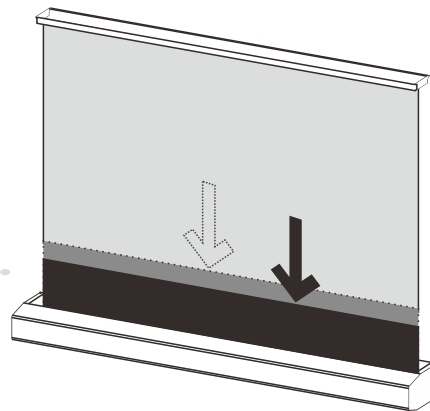

1

Press and hold the green button on the remote control until the screen emits 1 long and 3 short Beeps (sound)

2

Click the DOWN button on the remote control to adjust the height of the projected screen to a suitable position.

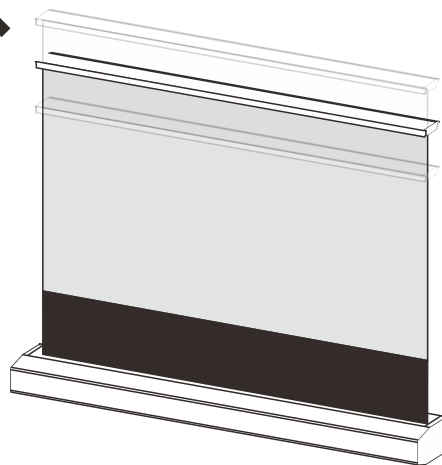
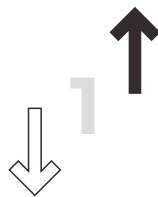
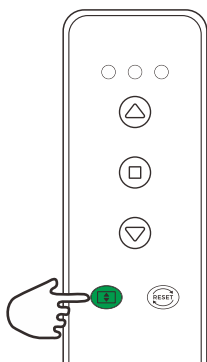

3

Press and hold the green button on the remote control for 5 seconds until the screen appears ↑ ↓, and then the screen height adjustment is completed.

Reset | Restore the factory setting position

Press and hold the red RESET button on the remote control until the screen surface moves ↑ ↓, process completed.

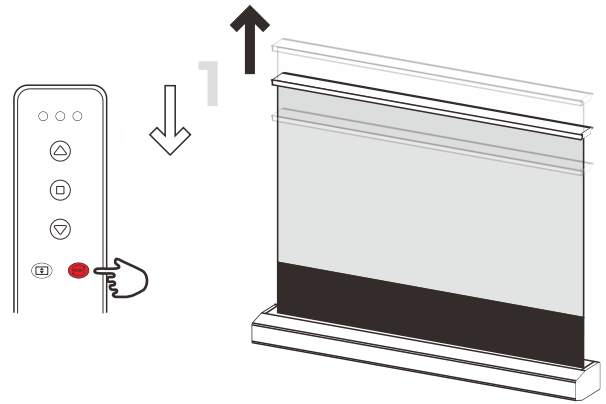

Remote Unpairing

Press and hold the Learn button on the end cap, and the screen will display two prompt actions, up and down, process completed.

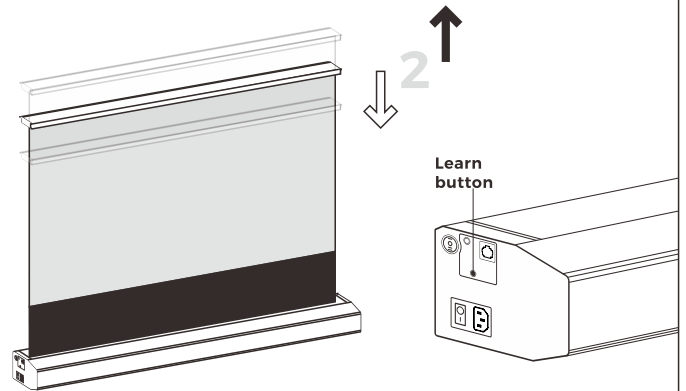

Remote Pairing

Power on, press and hold the UP button on the remote control (operate within 20 seconds) until the screen surface runs ↑ ↓ once, process completed.



The remote control has already been completed the pairing and is ready to use, relearning only if necessary.

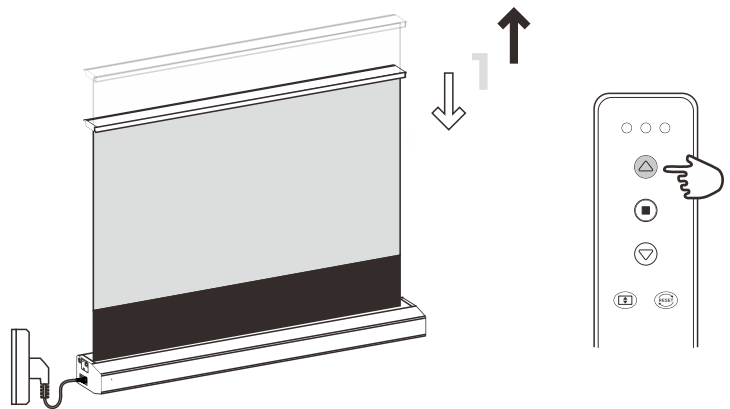

Instructions for the “Beep” sound during debugging:

| | |
|-----------------------------------|---|
| Single “Beep”: | During debugging |
| Two “Beeps”: | The child lock function is activated |
| One long and Two short “Beeps”: | The screen height has reached the limit |
| One long and Three short “Beeps”: | Entered the screen height debugging mode. |

During the setting process

Press and Hold: the screen surface will move up/down continuously.

Click: the screen surface will adjust by 5mm each time.

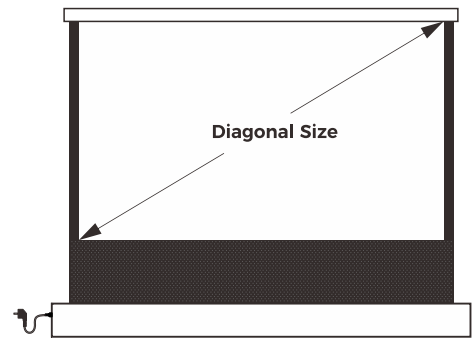
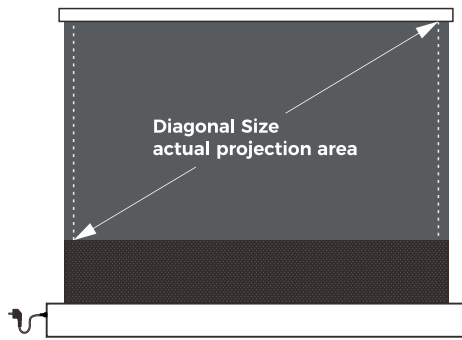
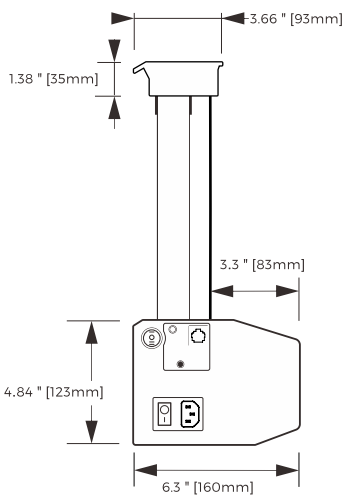
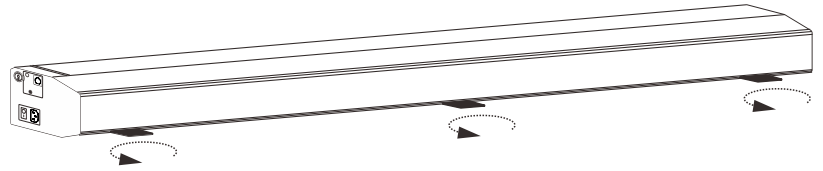
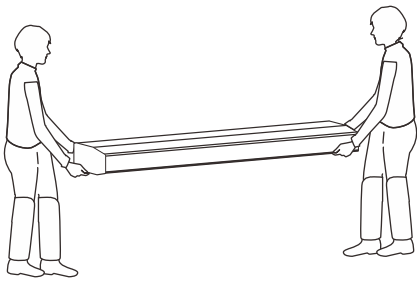

Fault Analysis and Elimination

A. What if your remote doesn't work?

Press any of the "Up", "Down" or "Stop" buttons on the remote control. If the indicator does not light up, means the battery is low. Replace/Plug in the charging power source.

B. What if you cannot pair the remote?

Please unpair it first then proceed with pairing (refer to ADJUSTMENT AND USAGE section of this manual).

C. What if your screen doesn't respond to the remote control?

The internal relay of the screen has a "Clack" sound. Please screw open the end cap to check if the wiring is in good shape. If the wiring looks good, it is recommended to replace the motor. If the relay has no response, try to replace the circuit board.

D. What if the synchronizer (optional) does not synchronize with the screen after pairing?

Restart the projector and wait for 2 minutes then press the Learn button (on the screen end cap) until the screen automatically goes up and down, Press the Learn button on the synchronizer side afterward to check whether the indicator is flashing, and try to replace the synchronizer if not.

SYNCHRONIZER

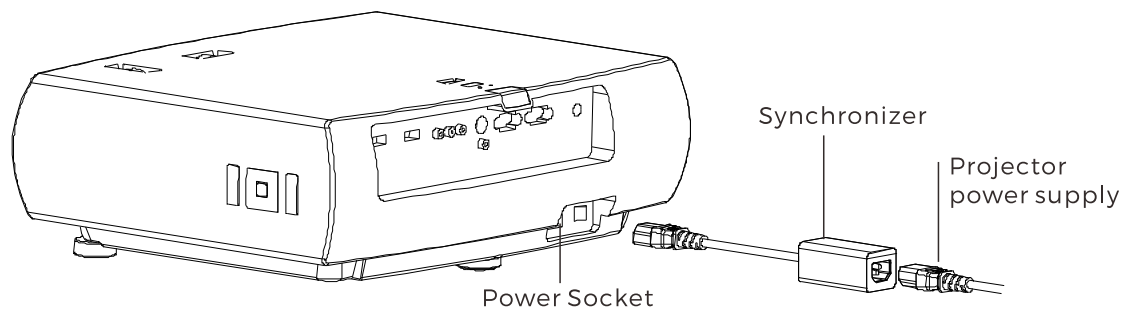

Pairing:

Turn on the projector and wait for the projected image to appear.

Then, within 20 seconds after powering on the screen, press and hold the synchronizer Learn key until the screen surface runs up and down.

Press and hold the synchronizer Learn key until the indicator light changes and the process is completed.

